



JBL Stage A6002/A6004/A9004/A3001

THANK YOU FOR YOUR PURCHASE . . .

Your JBL product has been designed to provide you with the performance and ease of operation you would expect from JBL.

- Please take time to read your owner's manual in its entirety before operating or installing your amplifier.
- Keep the owner's manual for your amplifier in your glove compartment along with the owner's manual for your car.
- Put your amplifier sales receipt with other important documents in order to expedite warranty service if needed.

ABOUT THE MANUAL

This manual describes general installation guidelines and operation instructions. However, please note that proper installation of mobile audio and video components requires qualified experience with mechanical and electrical procedures. If you do not have the knowledge and tools to successfully perform this installation, we strongly recommend consulting an authorized JBL dealer about your installation options. Keep all instructions and sales receipts for reference. Consider this manual as an indispensable feature of your amplifier.

EN

CHAPTER 1: PICTORIAL INDEX OF INPUT CONNECTIONS

Stage Amplifier left side panel

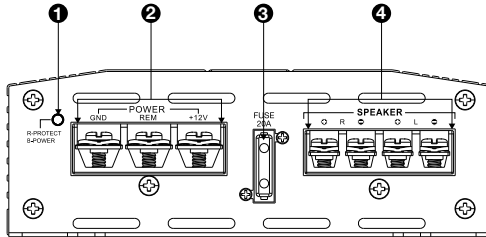

Stage A6002

Stage Amplifier right side panel

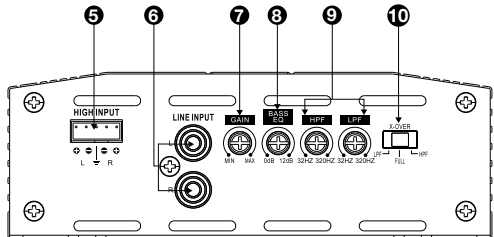

Stage A6002

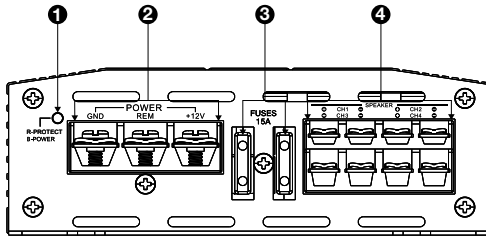

Stage A6004 and A9004

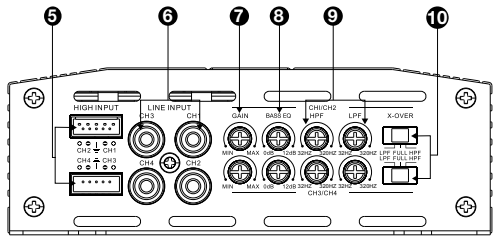

Stage A6004 and A9004

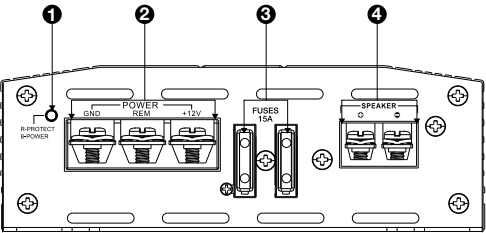

Stage A3001

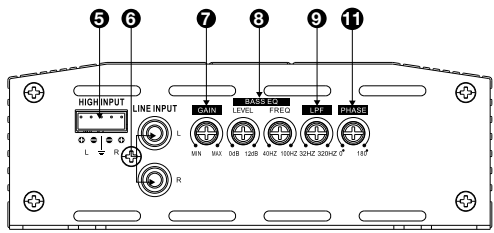

Stage A3001

1. Power/protect indicator
2. Power input connectors
3. Fuse(s)
4. Speaker output connectors
5. High-level input(s)
6. Line-level inputs (RCA)

7. Gain (input sensitivity)
8. Bass EQ control(s)
9. Crossover frequency control(s)
10. Crossover filter selector(s)
11. Subwoofer phase selector

CHAPTER 2: INSTALLATION AND WIRING

What's in the box:

- 1x amplifier
- 4x mounting screws x4
- Spare fuse (x1 for A6002, x2 for A3001, A6004 and A9004)

- High-level input adapter (x1 for A6002 and A3001, x2 for A6004 and A9004)
- Mounting hardware
- Quick-start guide

Precautions:

IMPORTANT: Disconnect the vehicle's negative (-) battery terminal before beginning the installation.

- Always wear protective eyewear when using tools.
- Choose a safe mounting location, away from moisture. Check clearances on both sides of a planned mounting surface. Be sure that screws or wires will not puncture brake lines, fuel lines, or wiring harnesses and that wire routing will not interfere with the safe vehicle operation. Use caution when drilling or cutting in the mounting area.
- When making electrical connections, make sure they are secure and properly insulated.
- If you must replace any of the amplifier's fuses, use the same type of fuse and current rating as the original.
- To keep the amplifier cool, choose a location that provides enough air circulation, such as under a seat or in the trunk.
- Do not mount the amplifier with the heat sink facing downward, as this interferes with cooling.
- Mount the amplifier so that it will not be damaged by the feet of backseat passengers or shifting cargo in the trunk, and so that it remains dry.
- Using the amplifier as a template, mark the locations of the holes on the mounting surface.
- Drill pilot holes in the mounting surface.
- Attach the amplifier to the mounting surface with four appropriate mounting screws (not included). Recommended: #8 Phillips-head sheet metal screws.

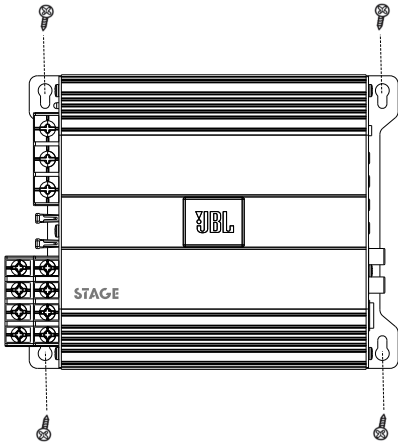

NOTE: You may find it more convenient to make all of the connections to the amplifier before you permanently mount it.

Power/protect indicator:

The light will illuminate in blue when the amp is receiving power and playing. The indicator will illuminate in red if the amp enters Protect mode in the event of conditions such as over/under voltage, short circuit, amplifier output circuit failure, or excessive heat.

Power Input Connectors:

- **Power:** Run power wire from the +12V input to the positive terminal of the vehicle's battery. Insert bare wire into the terminal on the amplifier, then tighten the setscrew with a Phillips screwdriver.



- Install an appropriate fuse holder and fuse (20A minimum for Stage A6002 and 30A minimum for Stage A6004 and A3001, and 40A minimum for A9004) within 18" (457mm) of the battery. Make sure the wire is not damaged or pinched during installation. Install protective grommets when routing wires through the bulkhead or other sheet metal. Use larger-gauge wiring for longer runs.
 - o Stage A6002 minimum wire size: ≥10 gauge
 - o Stage A6004, A9004, A3001 minimum wire size: ≥8 gauge

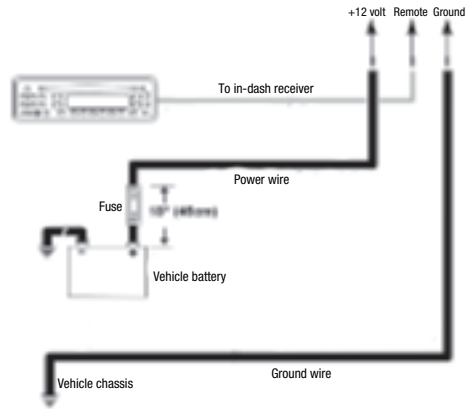

- **Ground:** Run a wire (the same gauge as the power wire) from the GND input to a factory bolt in the vehicle's chassis (see illustration below). **NOTE:** Remove any paint from the chassis for best contact. Use a star washer below the ring connector for a secure connection.

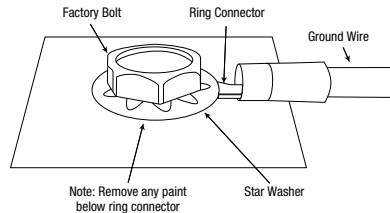

- **Remote:** Connect a 20-gauge wire from the "Remote Out" lead of the source unit to the REM input. This lead turns the amplifier on when using low-level input signals. If your stereo has no "Remote Out" lead, connect the amplifier's REM input to switched accessory power.

Fuses:

- Replace only with fuses of the same amperage:
 - o Stage A6002: 20A
 - o Stage A6004 and A3001: 15A x 2
 - o Stage A9004: 20A x 2

Speaker Output Connectors:

Connect the speakers to these terminals, observing proper polarity (connect each speaker's positive (+) lead to the appropriate positive (+) terminal, and negative (-) lead to the appropriate negative (-) terminal.

Stage A6002

- The Stage A6002 features L+, L-, R+, and R- terminals.
- 2-channel operation: Connect the left speaker to the L+ and L- terminals, and the right speaker to the R+ and R- terminals.

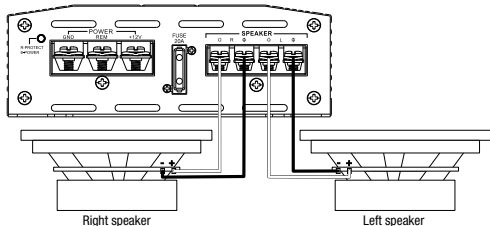

- o Bridged operation: Connect the positive wire from the single speaker or subwoofer to the R+ terminal, and the negative wire from the speaker or subwoofer to the L- terminal.

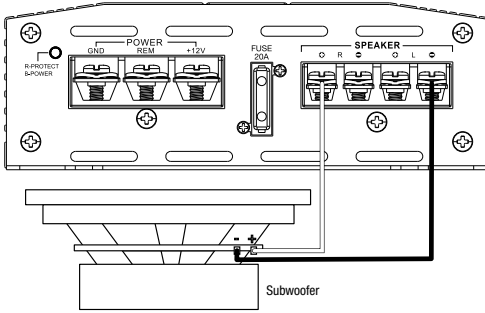

Stage A6004 and A9004

- The Stage A6004 and A9004 feature Channel 1 +/-, Channel 2 +/-, Channel 3 +/-, and Channel 4 +/- terminals.
- 4-channel operation:** Connect the front left speaker to the Channel 1 + and - terminals, and the front right speaker to the Channel 2 + and - terminals. Connect the rear left speaker to the Channel 3 + and - terminals, and the rear right speaker to the Channel 4 + and - terminals.

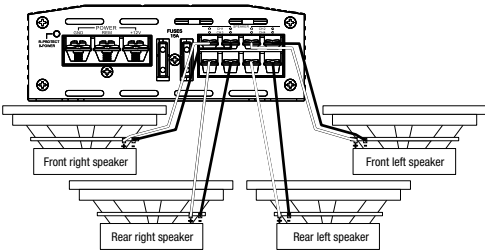

- 3-channel operation:** Connect the stereo speakers to the Channel 1 and Channel 2 terminals, as described above. Connect the single speaker's + lead to the Channel 3 + terminal, and the - lead to the Channel 4 - terminal.

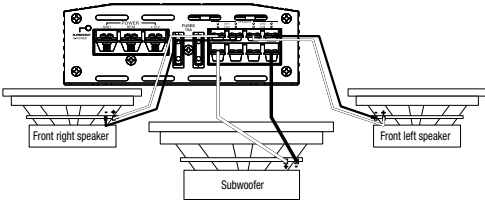

- 2-channel (bridged) operation:** Connect one speaker's + lead to the Channel 1 + terminal, and the - lead to the Channel 2 - terminal. Connect the other speaker's + lead to the Channel 3 + terminal, and the - lead to the Channel 4 - terminal.

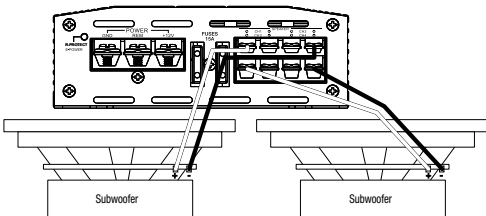

Stage A3001

- The Stage A3001 features a positive (+) and negative (-) terminals.
 - To power a single subwoofer, connect the subwoofer's positive (+) wire to the positive (+) terminal, and the subwoofer's negative (-) wire to the negative (-) terminal.

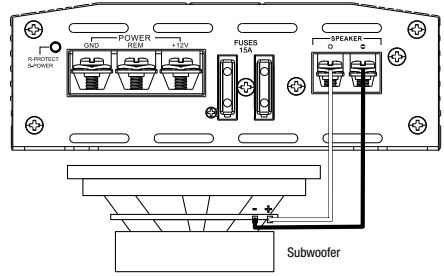

- To power two subwoofers in parallel, connect one sub's positive (+) and negative (-) leads to the positive and negative terminals of the other sub, then connect that subwoofer's positive (+) wire to the positive (+) terminal, and the subwoofer's negative (-) wire to the negative (-) terminal.

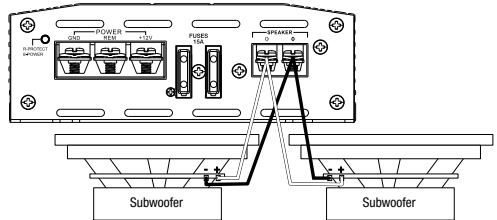

NOTE: Minimum speaker impedance for stereo full-range and subwoofer operation is 2 ohms. Minimum speaker impedance for bridged operation is 4 ohms.

Line-level inputs and outputs (RCA):

If your source unit offers preamp outputs, connect to the L and R (A6002 and A3001), or CH1, CH2, CH3, and CH4 (A6004 and A9004) inputs using RCA patch cables.

High-level audio input:

If your car audio system's head unit does not have line-level outputs: Connect the white, white/black, gray, and gray/black wires of the included high-level input harness(es) to the front and/or rear speaker output wires of your car audio system's head unit (splice crimps not included), and the black wire to vehicle chassis ground. Then plug the high-level harness into the Stage amplifier's high-level input.

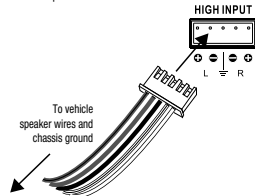

Important: Some factory-installed audio system amplifiers include electronic filters that limit the amount of bass sent to the system's smaller speakers. This filtering will adversely affect the Stage amp's performance. To get the most bass possible from your Stage amp, splice the high-level harness into the factory system speaker outputs that are connected to the system's largest speakers (the ones designed to reproduce the most bass).

Input sensitivity (GAIN):

Input level controls. Use these to match the amp's input sensitivity to the output level of your source unit. See Setting the input levels in Chapter 3 for a recommended adjustment procedure.

Crossover filter selectors (X-OVER):

Let you choose the crossover filters for your system (the Stage A3001 filter is low-pass only).

- LPF:** Low pass. Choose this setting if you're connecting a subwoofer(s), or want to provide a low-pass filter for separate mid-bass speakers.
- FULL:** Full range. Choose this setting if you're connecting full-range speakers, and not using a subwoofer in your system.
- HPF:** High pass. Choose this setting to prevent low bass from reaching midrange or full-range speakers when you're using a subwoofer in your system. (See setting the crossovers in Chapter 3.)

Crossover-filter frequency controls (FREQ):

Turn the dials to the left to lower the crossover point, and to the right to raise the crossover point. Crossover point settings vary by listener preference.

CHAPTER 3: OPERATIONS

Setting the input levels:

To match your amplifier's input sensitivity (gain) to your source unit's output level, we recommend the following procedure:

- Turn both input level controls counterclockwise to MIN (minimum).
- Play a dynamic music track through your source unit. Turn the source unit's volume control to the 3/4 position.
- Turn the front input level control dial clockwise towards MAX until you hear distortion in the music (it's no longer clear).
- Slowly turn the front level input control dial counterclockwise until the music sounds clear again.
- Your front input level is now correctly set. Repeat this process with the rear channels.

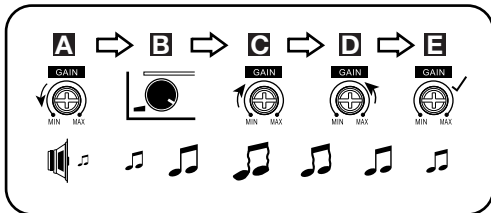

Setting the crossover

Properly setting crossover filter selectors optimizes frequency distribution for efficient speaker operation and best sound.

Step 1: Use the slider controls to select low-pass (LPF), FULL, or high-pass (HPF).

- LPF:** Low pass. Choose this setting if you are connecting a subwoofer(s) or want to provide a low-pass filter for separate mid-bass speakers.
- FULL:** Full range. Choose this setting if you are connecting full-range speakers and are not using a subwoofer in your system.
- HPF:** High pass. Choose this setting to prevent low bass from reaching midrange or full-range speakers when you are using a subwoofer in your system.

Step 2: Use crossover-filter frequency controls to adjust crossover point settings for coaxial speakers and subwoofers to suit listener preference. Turn the dials to the left to lower the crossover point and to the right to raise the crossover point. Exact crossover settings for coaxial speakers and subwoofers finally depend on your listening preferences. NOTE: crossover point does not apply in FULL mode.

Selecting the subwoofer phase

With the Stage A3001, you can choose a subwoofer phase output of 0° or 180°. To check your sub's phase, play music with lots of bass and listen as another person slowly turns the dial back and forth between 0 and 180 degrees. The correct setting is the one that gives you more bass. If you don't detect any real difference, leave the dial in the 0 setting.



CHAPTER 5: SPECIFICATIONS

Model	RMS power @ 4 ohms	RMS power @ 2 ohms	RMS bridged power @ 4 ohms	Total peak power	Frequency response	Maximum high input signal level	High input maximum sensitivity	Maximum line input signal level
Stage A6002	60W	70W	140W	280W	20Hz – 20kHz @ -1 dB	12V	0.5V	5V
Stage A6004	60W	70W	140W	560W	20Hz – 20kHz @ -1 dB	12V	0.5V	5V
Stage A9004	90W	110W	220W	880W	20Hz – 20kHz @ -1 dB	12V	0.5V	5V
Stage A3001	N/A	300W	N/A	600W	10Hz – 320Hz @ -3 dB	12V	0.5V	5V

Model	Line input signal maximum sensitivity	Line-in signal-to-noise ratio (reference to 1 watt)	THD+ N at rated power (20Hz – 20kHz)	Fuse size	Dimensions (H x W x D)	Weight	Operating voltage	Quiescent current draw
Stage A6002	0.2V	>75dB	<1%	20A	95 x 230 x 190 (mm)	1.16kg	9 – 16V	<1.0A
Stage A6004	0.2V	>75dB	<1%	2 x 15A	95 x 260 x 190 (mm)	1.381kg	9 – 16V	<1.2A
Stage A9004	0.2V	>75dB	<1%	2 x 20A	95 x 325 x 190 (mm)	1.806kg	9 – 16V	<1.5A
Stage A3001	0.2V	>75dB	<1%	2 x 15A	95 x 313 x 190 (mm)	1.609kg	9 – 16V	<1.5A

LEVEL



FREQ



Bass EQ level and frequency:

You can increase the bass output of your system with the Bass EQ feature up to +12dB. Turn the LEVEL dials to the right to increase the bass output.

The Stage 3001A also lets you choose the center frequency of the bass boost – the frequency that receives the most boost effect. Turn the FREQ dial to the right to adjust the center frequency. The frequency you choose depends on your listening preferences.

CHAPTER 4: TROUBLESHOOTING

PROBLEM: No audio and POWER INDICATOR is off.
CAUSE and SOLUTION: No voltage at BATT+ and/or REM terminals, or bad or no ground connection. Check voltages at amplifier terminals with VOM.

PROBLEM: No audio and PROTECT INDICATOR flashes every 4 seconds.
CAUSE and SOLUTION: DC voltage on amplifier output. Amplifier may need service; see enclosed warranty card for service information.

PROBLEM: No audio and PROTECT INDICATOR is on.
CAUSE and SOLUTION: Amplifier is overheated. Make sure amplifier cooling is not blocked at mounting location. Verify that speaker-system impedance is within specified limits. Or, there may be voltage greater than 16V (or less than 8.5V) on BATT+ connection. Check vehicle charging system.

PROBLEM: No audio and PROTECT and POWER INDICATORS flash.
CAUSE and SOLUTION: Voltage less than 9V on BATT+ connection. Check vehicle charging system.

PROBLEM: Distorted audio.
CAUSE and SOLUTION: Gain is not set properly. Check INPUT LEVEL setting. Check speaker wires for shorts or grounds. Amplifier or source unit may be defective.

PROBLEM: Distorted audio and PROTECT INDICATOR flashes.
CAUSE and SOLUTION: Short circuit in speaker or wire. Remove speaker leads one at a time to locate shorted speaker or wire, and repair.

PROBLEM: Music lacks dynamics or "punch."
CAUSE and SOLUTION: Speakers are not connected properly. Check speaker connections for proper polarity.

PROBLEM: Amplifier fuse keeps blowing.
CAUSE and PROBLEM: The wiring is connected incorrectly or there is a short circuit. Review installation precautions and procedures in manual. Check wiring connections.

PROBLEM: Engine noise—whining or clicking—in system when the engine is on.
CAUSE and PROBLEM: Amplifier is picking up alternator noise. Turn down gain. Move audio cables away from power wires. Install an alternator noise filter on power line between battery and alternator. Check ground connections on the amplifier since a loose or improper ground is one of the main causes for extraneous noise in your audio system.



HARMAN International Industries, Incorporated
 8500 Balboa Boulevard,
 Northridge, CA 91329 USA
www.jbl.com

© 2018 HARMAN International Industries, Incorporated. All rights reserved.

JBL is a trademark of HARMAN International Industries, Incorporated, registered in the United States and/or other countries. Features, specifications and appearance are subject to change without notice.